



Koningsdag Werkboekje Groep 3

Naam: _____

Koningssspelen

1. Kleur de voorkant van die boekje. >> Kleur 1 medaile.
2. Los een doolhof op in dit boekje. >> Kleur 1 medaile.
3. Ga naar Minipret.nl en speel een koningsdag spelletje. >> Kleur 1 medaile.

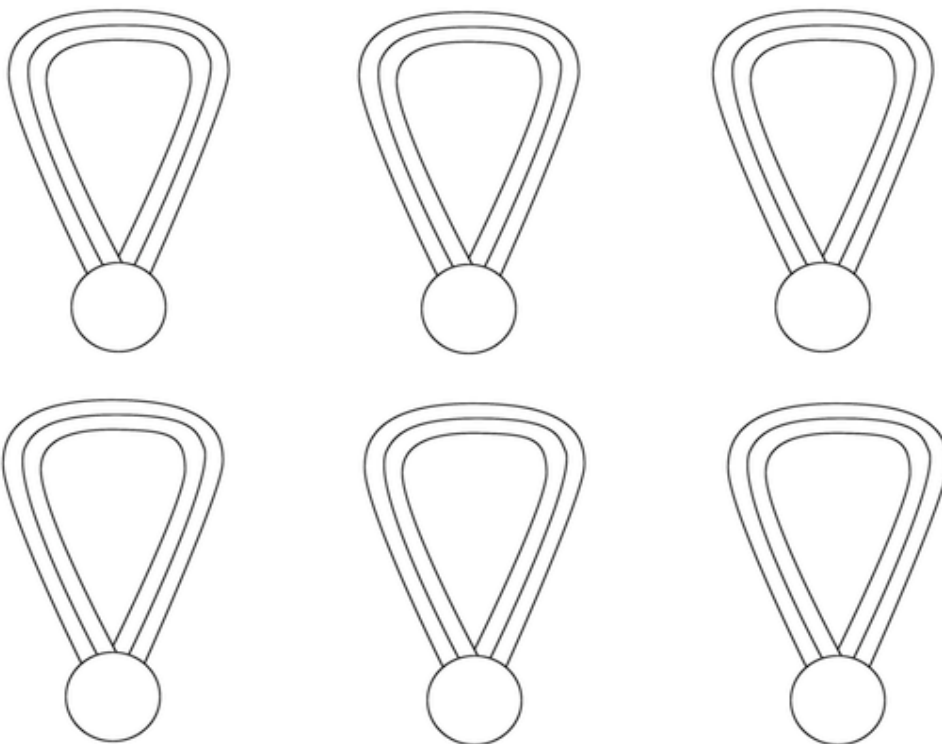

4. Maak een vlag in dit boekje. >> Kleur 1 medaile.
5. Teken een koning in dit boekje. >> Kleur 1 medaile.
6. Kleur een kleurplaat in dit boekje. >> Kleur 1 medaile.

Doolhof

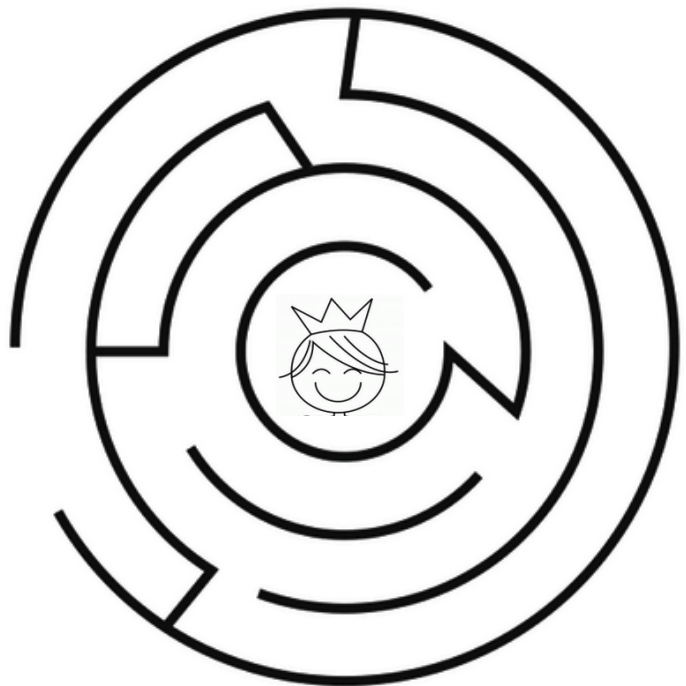
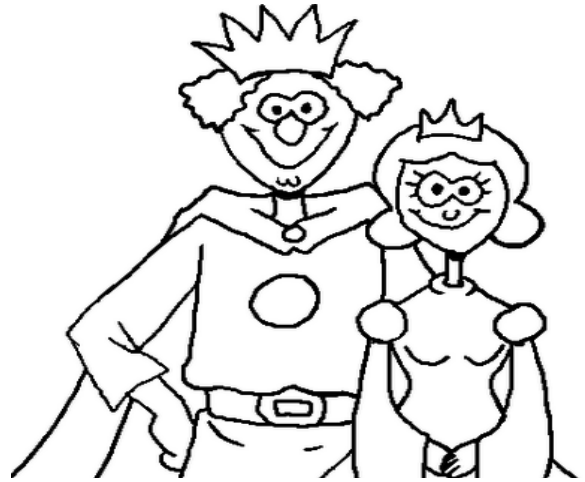



Woorden zoeken



Verbind dezelfde woorden met elkaar.

Feest

Amsterdam

Koning

Prinses

Amalia

Ijs

Amsterdam

Confetti

Prinses

Feest

Confetti

Koning

Ijs

Amalia

Maak de Nederlandse vlag!

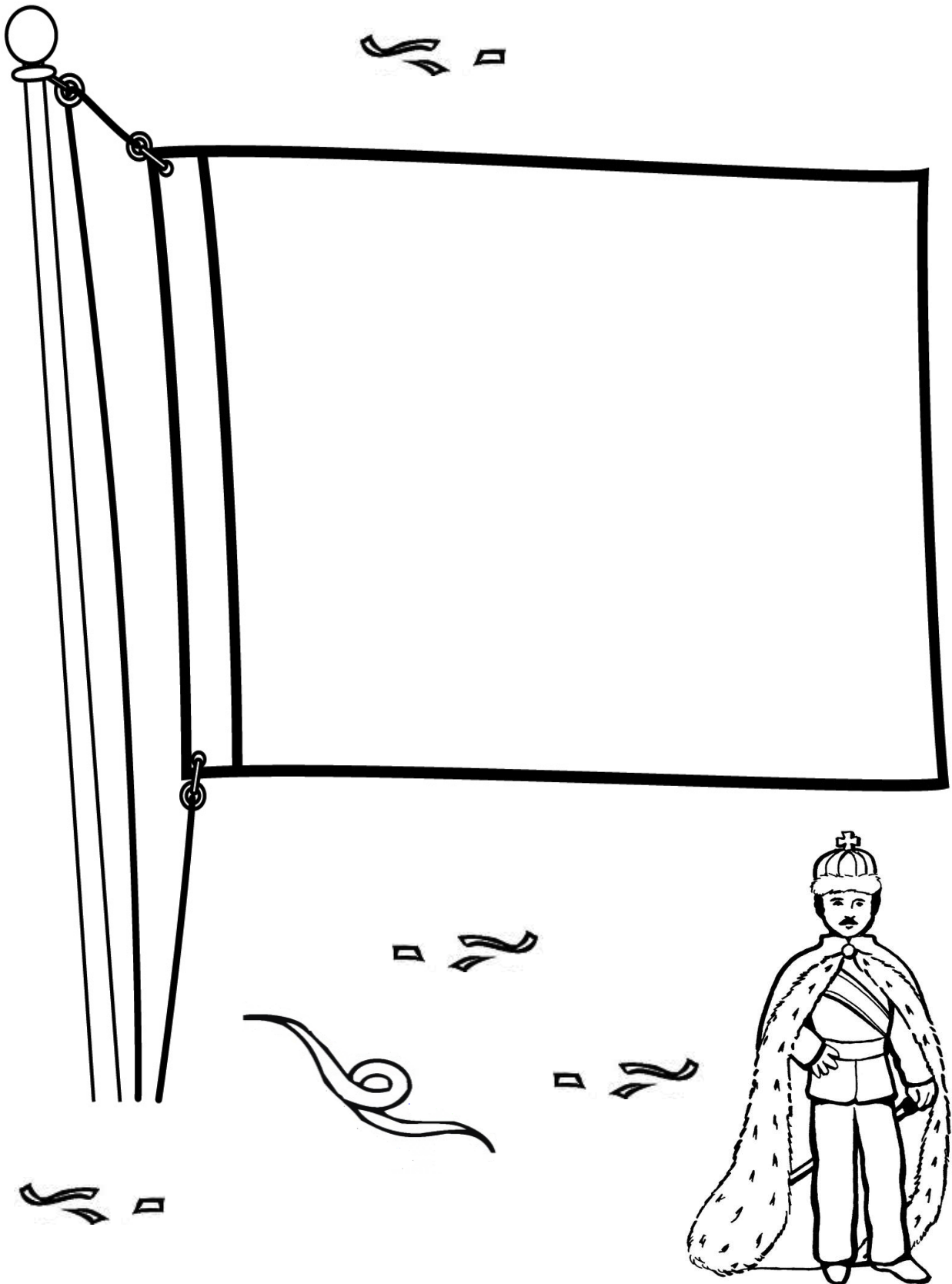

Kleurplaat

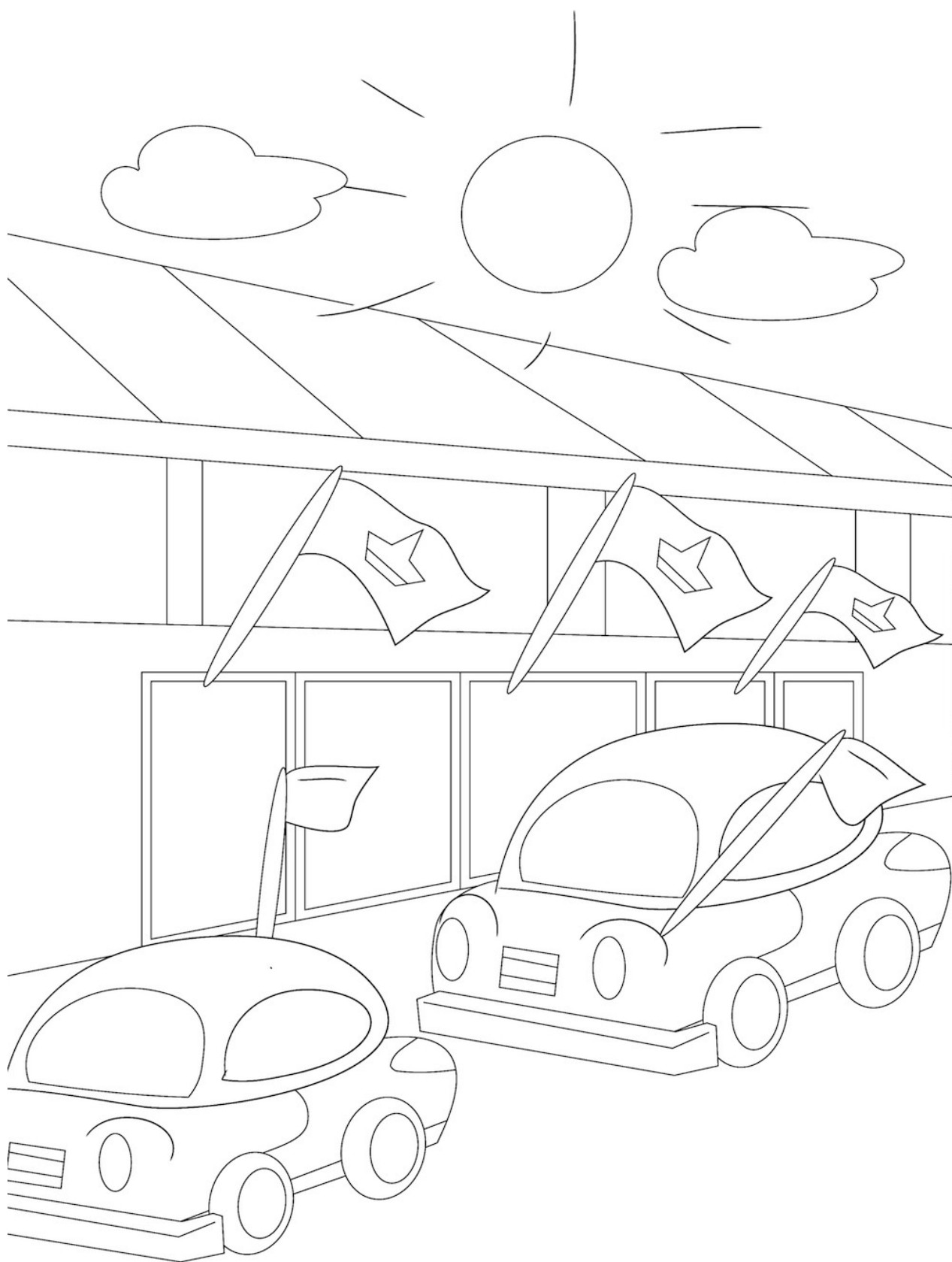

Verbinden

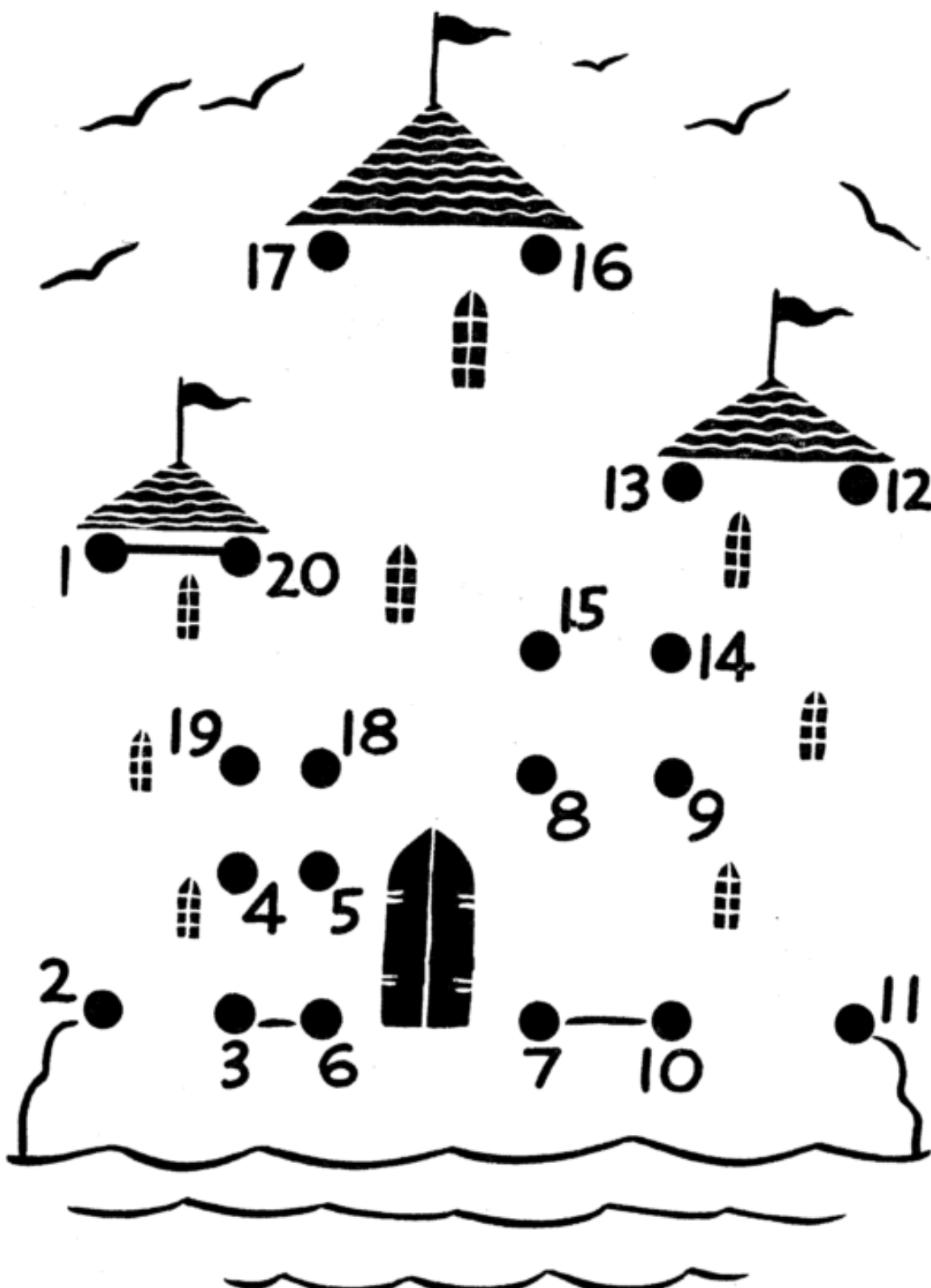

Kleurplaat

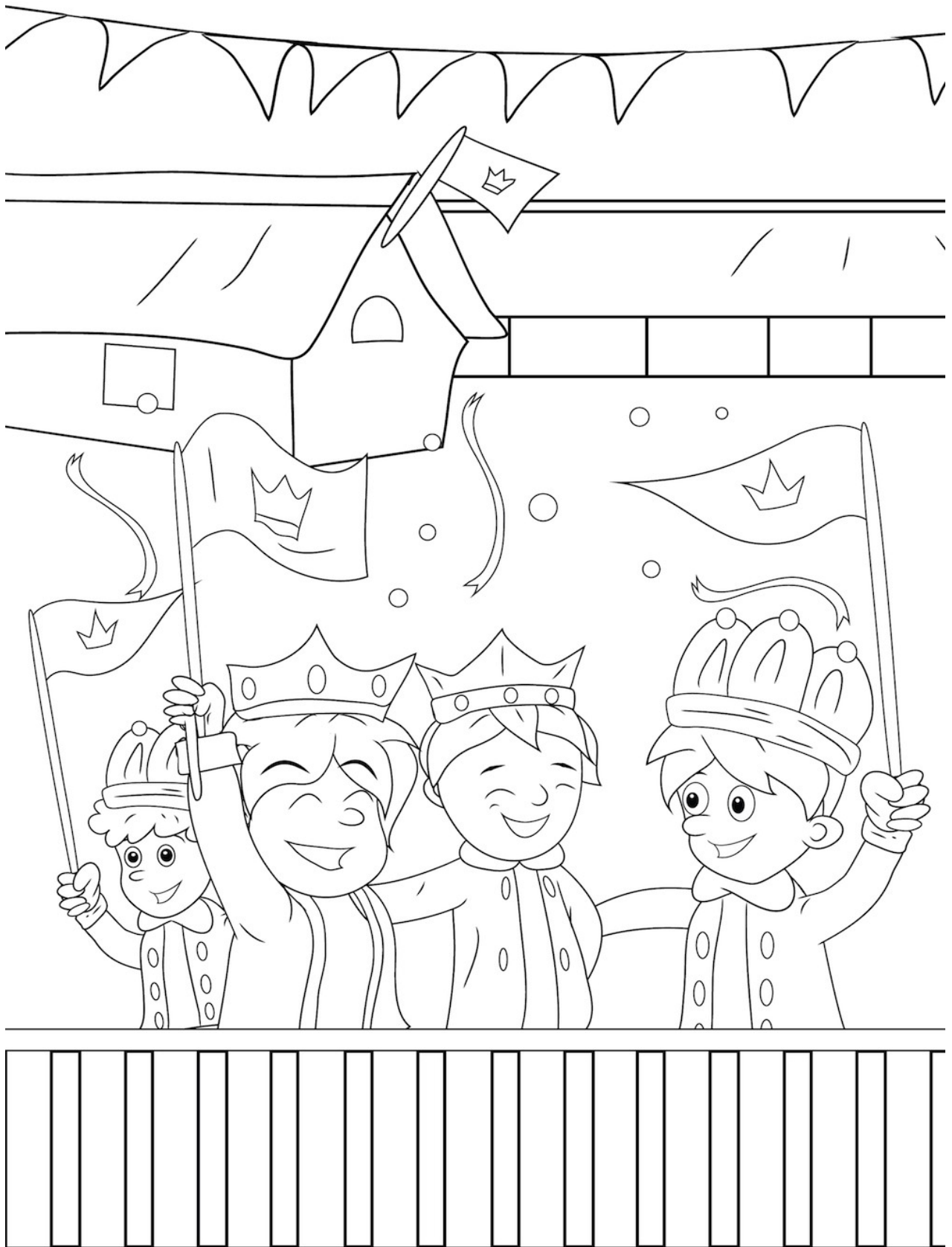

Tellen



De koning wil weten hoe goed jij kan tellen.
Schrijf zoveel mogelijk getallen op.

1 13 25

2 14 26

3 15 27

4 16 28

5 17 29

6 18 30

7 19 31

8 20 32

9 21 33

10 22 34

11 23 35

12 24 36

Teken de Koning

Kleur de troon en teken er een koning bij.

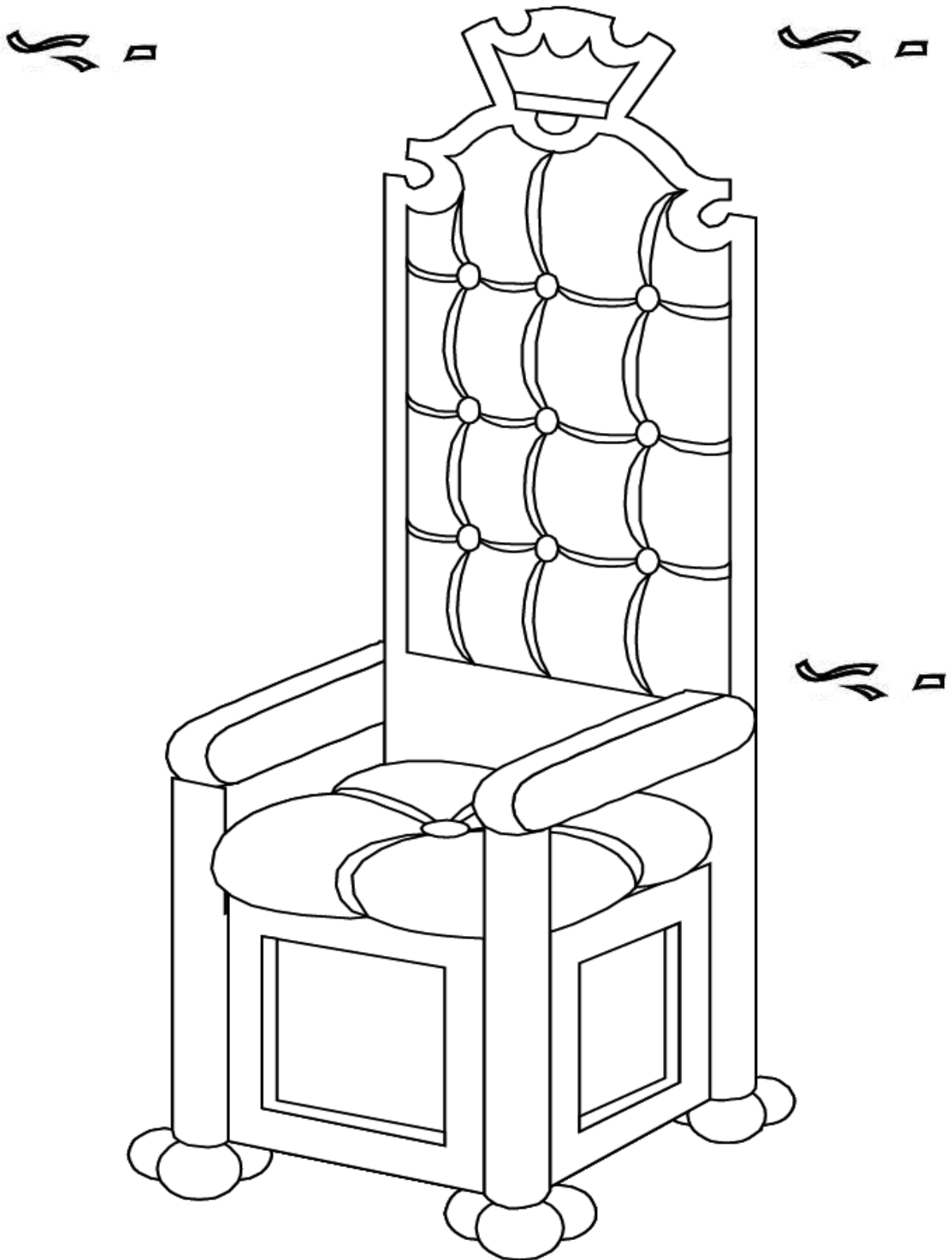



Rekenspelletje

De koning en koningin zijn gek op spelletjes.
Kan jij ze helpen met deze sommen?

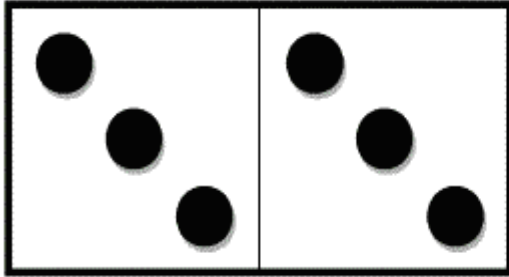

$$\underline{\quad} + \underline{\quad} = \underline{\quad}$$

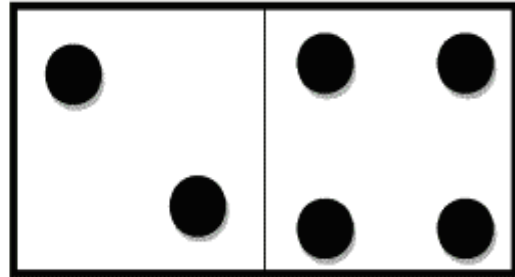

$$\underline{\quad} + \underline{\quad} = \underline{\quad}$$

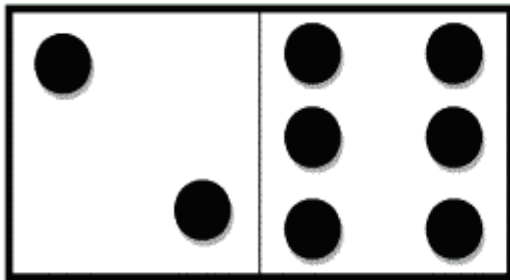

$$\underline{\quad} + \underline{\quad} = \underline{\quad}$$

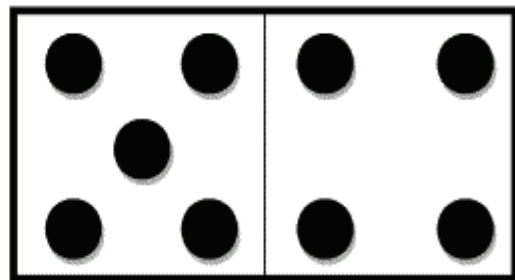

$$\underline{\quad} + \underline{\quad} = \underline{\quad}$$

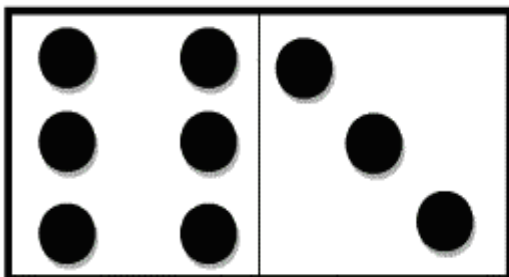

$$\underline{\quad} + \underline{\quad} = \underline{\quad}$$

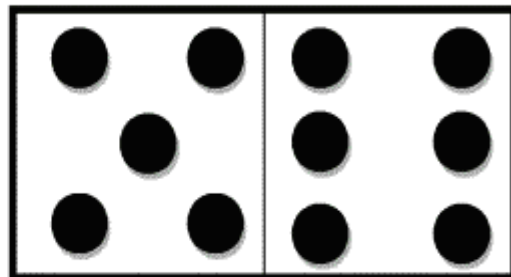

$$\underline{\quad} + \underline{\quad} = \underline{\quad}$$



Speel Koningsdag Spelletjes

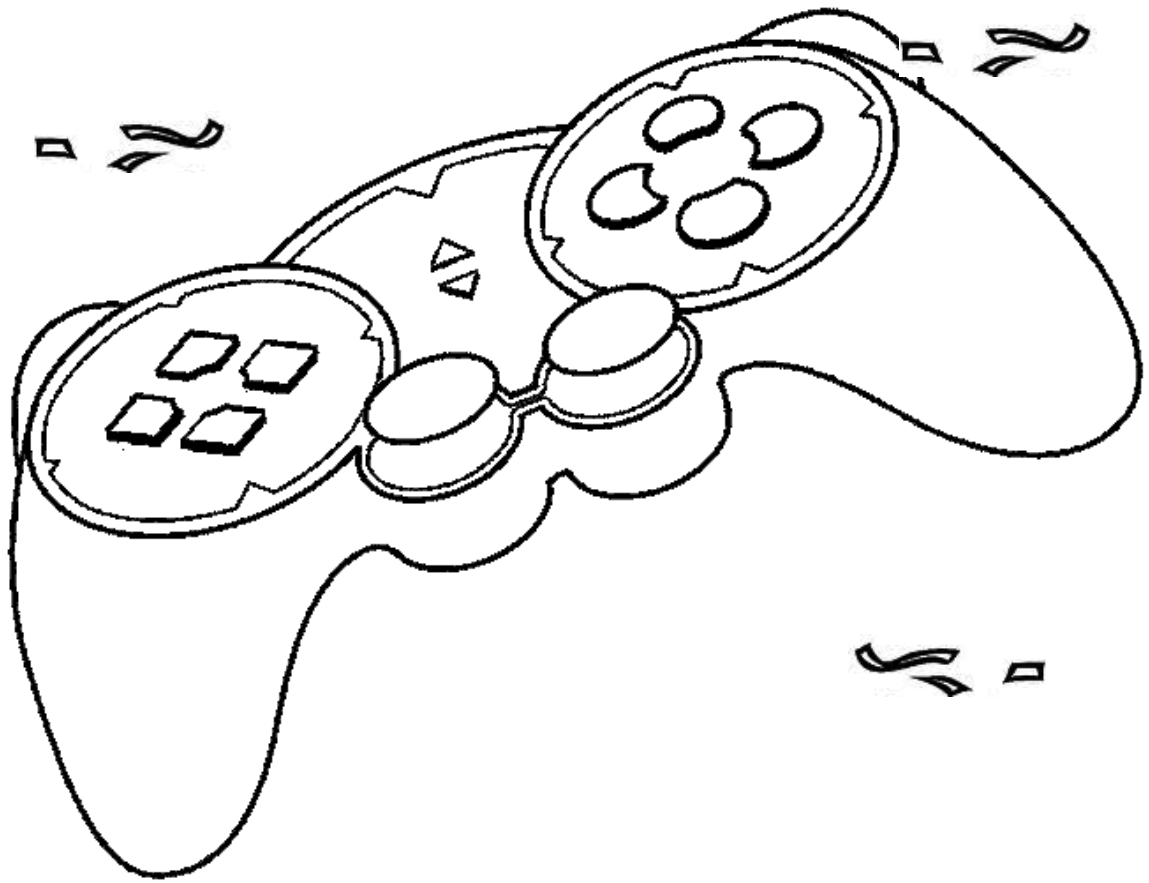

www.minipret.nl